

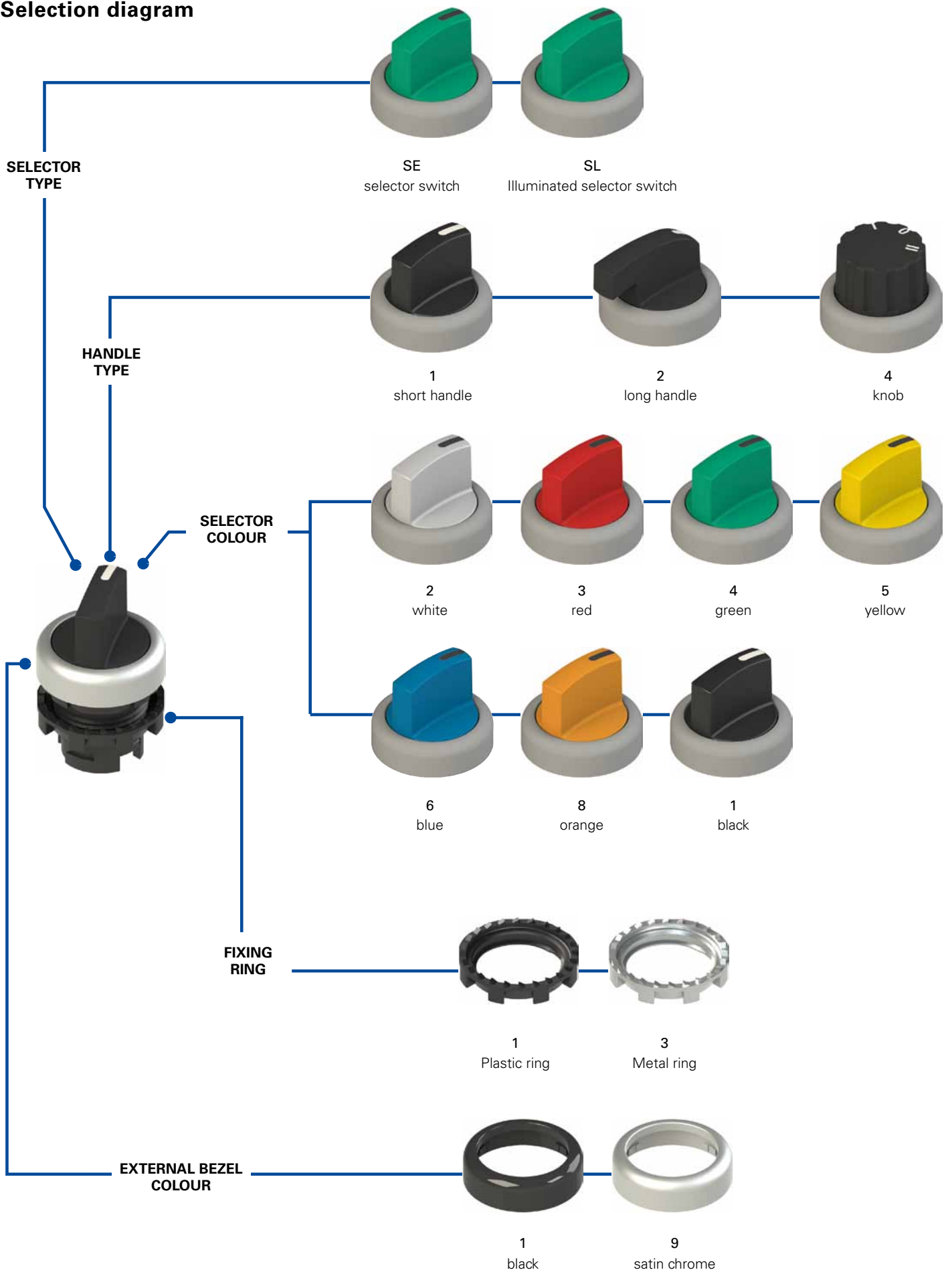









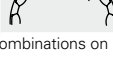





Selection diagram



Selector switches code structure **Attention!** The feasibility of a code number does not mean the effective availability of a product. Please contact our sales office.













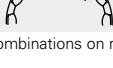

E2 1SE13ACE11AB



Fixing ring and shaped ring		Cams and actuators	Marking type	
1	Plastic ring (standard)		AB	 indication notch (standard)
2	Plastic fixing ring and shaped ring		AC	 only for knobs, positions 2AC, 2EC
3	Metal ring		AD	 only for knobs, positions 3AC, 3EC, 3FC, 3GC
4	Metal fixing ring and shaped ring	A	cam for 2-position selector switch for 3-slot base	Other combinations on request.
Handle type		E	cam for 3-position selector switch for 3-slot base	
1	short handle	Q	cam for 2-position selector switch for 4-slot base	
2	long handle	R	cam for 3-position selector switch for 4-slot base	
4	knob			
Positions		Selector colour		Bezel colour
2AV		2AC		1 black (standard)
2EV		2EC		9 satin chrome (standard)
2FV		3AC		
2FC		3EC		
2BC		3FC		
		3GC		
		4-position selector switches see p. 62		

Legend:  Maintained  Spring-return

Illuminated selector switch code structure **Attention!** The feasibility of a code number does not mean the effective availability of a product. Please contact our sales office.

E2 1SL13ACH21AB

Fixing ring and shaped ring		Cams and actuators	Marking type	
1	Plastic ring (standard)		AB	 indication notch (standard)
2	Plastic fixing ring and shaped ring		AC	 only for knobs, positions 2AC, 2EC
3	Metal ring		AD	 only for knobs, positions 3AC, 3EC, 3FC, 3GC
4	Metal fixing ring and shaped ring	D	Cam for 2-position selector switch	Other combinations on request.
Handle type		H	Cam for 3-position selector switch	
1	short handle			
2	long handle			
4	knob			
Positions		Selector colour		Bezel colour
2AV		2AC		1 black (standard)
2EV		2EC		9 satin chrome (standard)
2FV		3AC		
2FC		3EC		
2BC		3FC		
		3GC		
		4-position selector switches see p. 62		

Legend:  Maintained  Spring-return



Main features

- Protection degrees IP67 and IP69K
- 4 different shapes
- Standard or illuminated version
- Maintained or spring-return version

Quality marks:

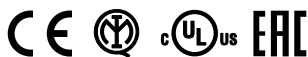

IMQ approval: CA02.04805
 UL approval: E131787
 EAC approval: RU C-IT DM94.B.01024

Technical data

General data

Protection degree:	IP67 acc. to EN 60529 IP69K acc. to ISO 20653
Ambient temperature:	-25°C ... +80°C
Safety parameter B _{10D} :	2,000,000
Mechanical endurance:	1 million operating cycles
Max. actuation frequency:	3600 operating cycles/hour
Actuating force at limit of travel:	0.07 Nm (without contacts)
Maximum travel:	60° (2 stable positions) 40° (2 momentary positions) ±60° (3 stable positions) ±40° (3 momentary positions)
Tightening torque of the fixing ring:	2 ... 2.5 Nm
Utilization requirements:	See page 139

In compliance with standards:

IEC 60947-1, IEC 60947-5-1, IEC 60204-1, EN 60947-1, EN 60947-5-1, EN 60204-1, UL 508, CSA 22-2 No. 14

⚠ Installation for safety applications:

Use only contact blocks marked with the symbol ⊕. The safety circuit must always be connected to **NC contacts** (normally closed contacts: .1-.2).

Compliance with the requirements of:

Low Voltage Directive 2014/35/EU, EMC Directive 2014/30/EU.

Positive contact opening in conformity with standards:

IEC 60947-5-1, EN 60947-5-1.

Features approved by UL

For Use on a Flat Surface of a Type 1, 4X, 12 and 13
 Tightening torque 2.0 Nm

General data

Protection degrees IP67 and IP69K

IP69K
IP67

These devices are designed to be used in the toughest environmental conditions and they pass the IP67 immersion test acc. to EN 60529. They can therefore be used in all environments where maximum protection degree of the housing is required. Due to their special design, these devices are suitable for use in equipment subjected to cleaning with high pressure hot water jets. These devices meet the IP69K test requirements according to ISO 20653 (water jets with 100 bar and a 80°C).

Metal fixing ring



The fixing ring in metal is particularly suitable for those applications which require tighter fitting of the panel-mounted device, such as for example in metal panels having holes without reference notches.

Shaped ring

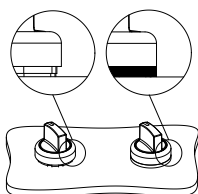

The shaped ring can be used when no label holder or other devices are applied; it prevents dirt and other residues from settling between the selector switch and the panel or housing. This turns out to be particularly useful in the sectors where high standards of cleanness and hygiene are required.

Actuators for selector switches

Three types of actuators are available, which activate the cursors of the contacts combined with the selector: a white actuator allowing the commutation of a single contact block, and a black or grey actuator allowing the simultaneous commutation of two contact blocks next to each other.

The white, black (3-slot base) and grey (4-slot base) actuators can be removed and replaced at any moment. This allows to configure at will the switching type executed by the selector on the contacts.

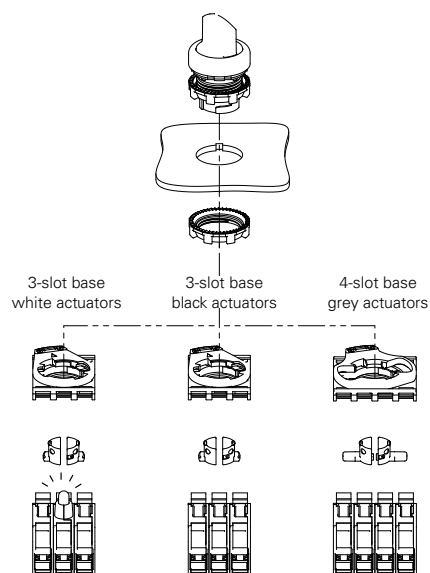

Selection table for selector switches



Actuator colour and engraving	Two positions	short handle		knob		long handle	
		black bezel	Satin chrome bezel	black bezel	Satin chrome bezel	black bezel	Satin chrome bezel
black		E2 1SE12AVA11AB	E2 1SE12AVA19AB	E2 1SE42AVA11AB	E2 1SE42AVA19AB	E2 1SE22AVA11AB	E2 1SE22AVA19AB
white		E2 1SE12AVA21AB	E2 1SE12AVA29AB	E2 1SE42AVA21AB	E2 1SE42AVA29AB	E2 1SE22AVA21AB	E2 1SE22AVA29AB
red		E2 1SE12AVA31AB	E2 1SE12AVA39AB	E2 1SE42AVA31AB	E2 1SE42AVA39AB	E2 1SE22AVA31AB	E2 1SE22AVA39AB
green		E2 1SE12AVA41AB	E2 1SE12AVA49AB	E2 1SE42AVA41AB	E2 1SE42AVA49AB	E2 1SE22AVA41AB	E2 1SE22AVA49AB
yellow		E2 1SE12AVA51AB	E2 1SE12AVA59AB	E2 1SE42AVA51AB	E2 1SE42AVA59AB	E2 1SE22AVA51AB	E2 1SE22AVA59AB
blue		E2 1SE12AVA61AB	E2 1SE12AVA69AB	E2 1SE42AVA61AB	E2 1SE42AVA69AB	E2 1SE22AVA61AB	E2 1SE22AVA69AB
orange		E2 1SE12AVA81AB	E2 1SE12AVA89AB	E2 1SE42AVA81AB	E2 1SE42AVA89AB	E2 1SE22AVA81AB	E2 1SE22AVA89AB
black		E2 1SE12EVA11AB	E2 1SE12EVA19AB	E2 1SE42EVA11AB	E2 1SE42EVA19AB	E2 1SE22EVA11AB	E2 1SE22EVA19AB
white		E2 1SE12EVA21AB	E2 1SE12EVA29AB	E2 1SE42EVA21AB	E2 1SE42EVA29AB	E2 1SE22EVA21AB	E2 1SE22EVA29AB
red		E2 1SE12EVA31AB	E2 1SE12EVA39AB	E2 1SE42EVA31AB	E2 1SE42EVA39AB	E2 1SE22EVA31AB	E2 1SE22EVA39AB
green		E2 1SE12EVA41AB	E2 1SE12EVA49AB	E2 1SE42EVA41AB	E2 1SE42EVA49AB	E2 1SE22EVA41AB	E2 1SE22EVA49AB
yellow		E2 1SE12EVA51AB	E2 1SE12EVA59AB	E2 1SE42EVA51AB	E2 1SE42EVA59AB	E2 1SE22EVA51AB	E2 1SE22EVA59AB
blue		E2 1SE12EVA61AB	E2 1SE12EVA69AB	E2 1SE42EVA61AB	E2 1SE42EVA69AB	E2 1SE22EVA61AB	E2 1SE22EVA69AB
orange		E2 1SE12EVA81AB	E2 1SE12EVA89AB	E2 1SE42EVA81AB	E2 1SE42EVA89AB	E2 1SE22EVA81AB	E2 1SE22EVA89AB
black		E2 1SE12ACA11AB	E2 1SE12ACA19AB	E2 1SE42ACA11AB	E2 1SE42ACA19AB	E2 1SE22ACA11AB	E2 1SE22ACA19AB
white		E2 1SE12ACA21AB	E2 1SE12ACA29AB	E2 1SE42ACA21AB	E2 1SE42ACA29AB	E2 1SE22ACA21AB	E2 1SE22ACA29AB
red		E2 1SE12ACA31AB	E2 1SE12ACA39AB	E2 1SE42ACA31AB	E2 1SE42ACA39AB	E2 1SE22ACA31AB	E2 1SE22ACA39AB
green		E2 1SE12ACA41AB	E2 1SE12ACA49AB	E2 1SE42ACA41AB	E2 1SE42ACA49AB	E2 1SE22ACA41AB	E2 1SE22ACA49AB
yellow		E2 1SE12ACA51AB	E2 1SE12ACA59AB	E2 1SE42ACA51AB	E2 1SE42ACA59AB	E2 1SE22ACA51AB	E2 1SE22ACA59AB
blue		E2 1SE12ACA61AB	E2 1SE12ACA69AB	E2 1SE42ACA61AB	E2 1SE42ACA69AB	E2 1SE22ACA61AB	E2 1SE22ACA69AB
orange		E2 1SE12ACA81AB	E2 1SE12ACA89AB	E2 1SE42ACA81AB	E2 1SE42ACA89AB	E2 1SE22ACA81AB	E2 1SE22ACA89AB
black		E2 1SE12ECA11AB	E2 1SE12ECA19AB	E2 1SE42ECA11AB	E2 1SE42ECA19AB	E2 1SE22ECA11AB	E2 1SE22ECA19AB
white		E2 1SE12ECA21AB	E2 1SE12ECA29AB	E2 1SE42ECA21AB	E2 1SE42ECA29AB	E2 1SE22ECA21AB	E2 1SE22ECA29AB
red		E2 1SE12ECA31AB	E2 1SE12ECA39AB	E2 1SE42ECA31AB	E2 1SE42ECA39AB	E2 1SE22ECA31AB	E2 1SE22ECA39AB
green		E2 1SE12ECA41AB	E2 1SE12ECA49AB	E2 1SE42ECA41AB	E2 1SE42ECA49AB	E2 1SE22ECA41AB	E2 1SE22ECA49AB
yellow		E2 1SE12ECA51AB	E2 1SE12ECA59AB	E2 1SE42ECA51AB	E2 1SE42ECA59AB	E2 1SE22ECA51AB	E2 1SE22ECA59AB
blue		E2 1SE12ECA61AB	E2 1SE12ECA69AB	E2 1SE42ECA61AB	E2 1SE42ECA69AB	E2 1SE22ECA61AB	E2 1SE22ECA69AB
orange		E2 1SE12ECA81AB	E2 1SE12ECA89AB	E2 1SE42ECA81AB	E2 1SE42ECA89AB	E2 1SE22ECA81AB	E2 1SE22ECA89AB

Legend: Maintained Spring-return
 Items with code on **green** background are stock items

On request, knob selector switches can be customized with symbols and inscriptions.

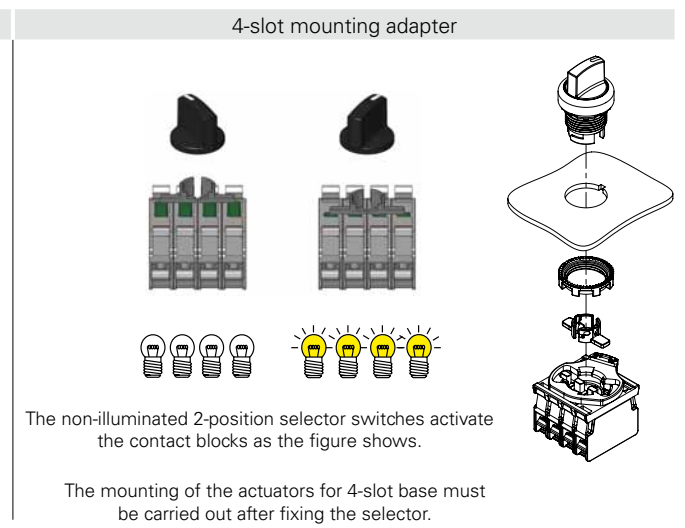
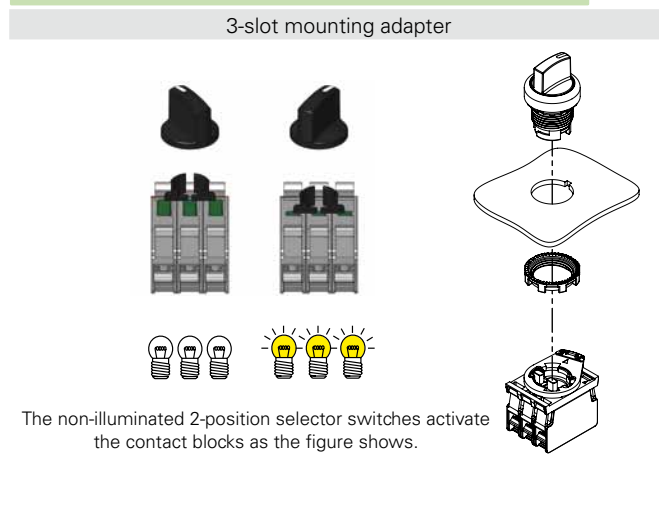

Selection table for selector switches



Actuator colour and engraving	Three positions	short handle		knob		long handle	
		black bezel	Satin chrome bezel	black bezel	Satin chrome bezel	black bezel	Satin chrome bezel
● black	↙	E2 1SE13ACE11AB	E2 1SE13ACE19AB	E2 1SE43ACE11AB	E2 1SE43ACE19AB	E2 1SE23ACE11AB	E2 1SE23ACE19AB
○ white	↘	E2 1SE13ACE21AB	E2 1SE13ACE29AB	E2 1SE43ACE21AB	E2 1SE43ACE29AB	E2 1SE23ACE21AB	E2 1SE23ACE29AB
● red	↙	E2 1SE13ACE31AB	E2 1SE13ACE39AB	E2 1SE43ACE31AB	E2 1SE43ACE39AB	E2 1SE23ACE31AB	E2 1SE23ACE39AB
● green	↘	E2 1SE13ACE41AB	E2 1SE13ACE49AB	E2 1SE43ACE41AB	E2 1SE43ACE49AB	E2 1SE23ACE41AB	E2 1SE23ACE49AB
● yellow	↙	E2 1SE13ACE51AB	E2 1SE13ACE59AB	E2 1SE43ACE51AB	E2 1SE43ACE59AB	E2 1SE23ACE51AB	E2 1SE23ACE59AB
● blue	↘	E2 1SE13ACE61AB	E2 1SE13ACE69AB	E2 1SE43ACE61AB	E2 1SE43ACE69AB	E2 1SE23ACE61AB	E2 1SE23ACE69AB
● orange	↙	E2 1SE13ACE81AB	E2 1SE13ACE89AB	E2 1SE43ACE81AB	E2 1SE43ACE89AB	E2 1SE23ACE81AB	E2 1SE23ACE89AB
● black	↙↘	E2 1SE13ECE11AB	E2 1SE13ECE19AB	E2 1SE43ECE11AB	E2 1SE43ECE19AB	E2 1SE23ECE11AB	E2 1SE23ECE19AB
○ white	↘↙	E2 1SE13ECE21AB	E2 1SE13ECE29AB	E2 1SE43ECE21AB	E2 1SE43ECE29AB	E2 1SE23ECE21AB	E2 1SE23ECE29AB
● red	↙↘	E2 1SE13ECE31AB	E2 1SE13ECE39AB	E2 1SE43ECE31AB	E2 1SE43ECE39AB	E2 1SE23ECE31AB	E2 1SE23ECE39AB
● green	↘↙	E2 1SE13ECE41AB	E2 1SE13ECE49AB	E2 1SE43ECE41AB	E2 1SE43ECE49AB	E2 1SE23ECE41AB	E2 1SE23ECE49AB
● yellow	↙↘	E2 1SE13ECE51AB	E2 1SE13ECE59AB	E2 1SE43ECE51AB	E2 1SE43ECE59AB	E2 1SE23ECE51AB	E2 1SE23ECE59AB
● blue	↘↙	E2 1SE13ECE61AB	E2 1SE13ECE69AB	E2 1SE43ECE61AB	E2 1SE43ECE69AB	E2 1SE23ECE61AB	E2 1SE23ECE69AB
● orange	↙↘	E2 1SE13ECE81AB	E2 1SE13ECE89AB	E2 1SE43ECE81AB	E2 1SE43ECE89AB	E2 1SE23ECE81AB	E2 1SE23ECE89AB
● black	↙↘	E2 1SE13FCE11AB	E2 1SE13FCE19AB	E2 1SE43FCE11AB	E2 1SE43FCE19AB	E2 1SE23FCE11AB	E2 1SE23FCE19AB
○ white	↘↙	E2 1SE13FCE21AB	E2 1SE13FCE29AB	E2 1SE43FCE21AB	E2 1SE43FCE29AB	E2 1SE23FCE21AB	E2 1SE23FCE29AB
● red	↙↘	E2 1SE13FCE31AB	E2 1SE13FCE39AB	E2 1SE43FCE31AB	E2 1SE43FCE39AB	E2 1SE23FCE31AB	E2 1SE23FCE39AB
● green	↘↙	E2 1SE13FCE41AB	E2 1SE13FCE49AB	E2 1SE43FCE41AB	E2 1SE43FCE49AB	E2 1SE23FCE41AB	E2 1SE23FCE49AB
● yellow	↙↘	E2 1SE13FCE51AB	E2 1SE13FCE59AB	E2 1SE43FCE51AB	E2 1SE43FCE59AB	E2 1SE23FCE51AB	E2 1SE23FCE59AB
● blue	↘↙	E2 1SE13FCE61AB	E2 1SE13FCE69AB	E2 1SE43FCE61AB	E2 1SE43FCE69AB	E2 1SE23FCE61AB	E2 1SE23FCE69AB
● orange	↙↘	E2 1SE13FCE81AB	E2 1SE13FCE89AB	E2 1SE43FCE81AB	E2 1SE43FCE89AB	E2 1SE23FCE81AB	E2 1SE23FCE89AB
● black	↙↘	E2 1SE13GCE11AB	E2 1SE13GCE19AB	E2 1SE43GCE11AB	E2 1SE43GCE19AB	E2 1SE23GCE11AB	E2 1SE23GCE19AB
○ white	↘↙	E2 1SE13GCE21AB	E2 1SE13GCE29AB	E2 1SE43GCE21AB	E2 1SE43GCE29AB	E2 1SE23GCE21AB	E2 1SE23GCE29AB
● red	↙↘	E2 1SE13GCE31AB	E2 1SE13GCE39AB	E2 1SE43GCE31AB	E2 1SE43GCE39AB	E2 1SE23GCE31AB	E2 1SE23GCE39AB
● green	↘↙	E2 1SE13GCE41AB	E2 1SE13GCE49AB	E2 1SE43GCE41AB	E2 1SE43GCE49AB	E2 1SE23GCE41AB	E2 1SE23GCE49AB
● yellow	↙↘	E2 1SE13GCE51AB	E2 1SE13GCE59AB	E2 1SE43GCE51AB	E2 1SE43GCE59AB	E2 1SE23GCE51AB	E2 1SE23GCE59AB
● blue	↘↙	E2 1SE13GCE61AB	E2 1SE13GCE69AB	E2 1SE43GCE61AB	E2 1SE43GCE69AB	E2 1SE23GCE61AB	E2 1SE23GCE69AB
● orange	↙↘	E2 1SE13GCE81AB	E2 1SE13GCE89AB	E2 1SE43GCE81AB	E2 1SE43GCE89AB	E2 1SE23GCE81AB	E2 1SE23GCE89AB

Legend ↙ Maintained ↘ Spring-return

Items with code on **green** background are stock items

On request, knob selector switches can be customized with symbols and inscriptions.

3-slot mounting adapter

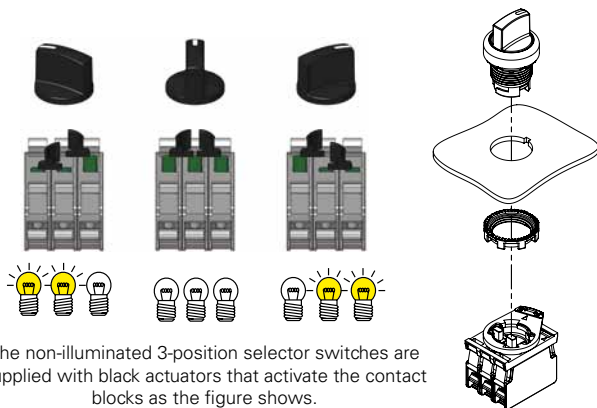

The non-illuminated 3-position selector switches are supplied with black actuators that activate the contact blocks as the figure shows.

4-slot mounting adapter

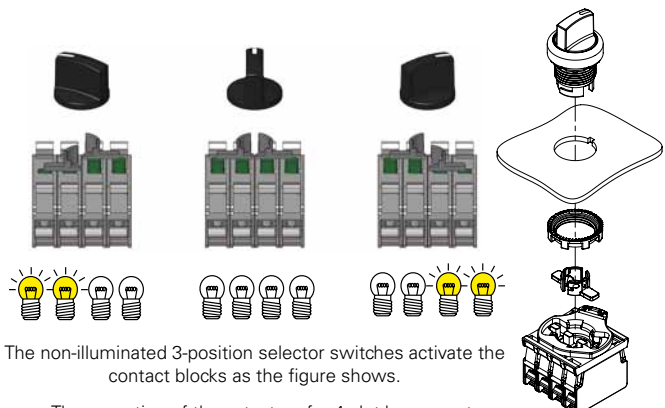

The non-illuminated 3-position selector switches activate the contact blocks as the figure shows.















The mounting of the actuators for 4-slot base must be carried out after fixing the selector.



Other configurations on request

Other configurations on request

Selection table for illuminated selector switches



Actuator colour and engraving	Two positions	short handle		knob		long handle	
		black bezel	Satin chrome bezel	black bezel	Satin chrome bezel	black bezel	Satin chrome bezel
 white		E2 1SL12AVD21AB	E2 1SL12AVD29AB	E2 1SL42AVD21AB	E2 1SL42AVD29AB	E2 1SL22AVD21AB	E2 1SL22AVD29AB
 red		E2 1SL12AVD31AB	E2 1SL12AVD39AB	E2 1SL42AVD31AB	E2 1SL42AVD39AB	E2 1SL22AVD31AB	E2 1SL22AVD39AB
 green		E2 1SL12AVD41AB	E2 1SL12AVD49AB	E2 1SL42AVD41AB	E2 1SL42AVD49AB	E2 1SL22AVD41AB	E2 1SL22AVD49AB
 yellow		E2 1SL12AVD51AB	E2 1SL12AVD59AB	E2 1SL42AVD51AB	E2 1SL42AVD59AB	E2 1SL22AVD51AB	E2 1SL22AVD59AB
 blue		E2 1SL12AVD61AB	E2 1SL12AVD69AB	E2 1SL42AVD61AB	E2 1SL42AVD69AB	E2 1SL22AVD61AB	E2 1SL22AVD69AB
 orange		E2 1SL12AVD81AB	E2 1SL12AVD89AB	E2 1SL42AVD81AB	E2 1SL42AVD89AB	E2 1SL22AVD81AB	E2 1SL22AVD89AB
 white		E2 1SL12EVD21AB	E2 1SL12EVD29AB	E2 1SL42EVD21AB	E2 1SL42EVD29AB	E2 1SL22EVD21AB	E2 1SL22EVD29AB
 red		E2 1SL12EVD31AB	E2 1SL12EVD39AB	E2 1SL42EVD31AB	E2 1SL42EVD39AB	E2 1SL22EVD31AB	E2 1SL22EVD39AB
 green		E2 1SL12EVD41AB	E2 1SL12EVD49AB	E2 1SL42EVD41AB	E2 1SL42EVD49AB	E2 1SL22EVD41AB	E2 1SL22EVD49AB
 yellow		E2 1SL12EVD51AB	E2 1SL12EVD59AB	E2 1SL42EVD51AB	E2 1SL42EVD59AB	E2 1SL22EVD51AB	E2 1SL22EVD59AB
 blue		E2 1SL12EVD61AB	E2 1SL12EVD69AB	E2 1SL42EVD61AB	E2 1SL42EVD69AB	E2 1SL22EVD61AB	E2 1SL22EVD69AB
 orange		E2 1SL12EVD81AB	E2 1SL12EVD89AB	E2 1SL42EVD81AB	E2 1SL42EVD89AB	E2 1SL22EVD81AB	E2 1SL22EVD89AB
 white		E2 1SL12ACD21AB	E2 1SL12ACD29AB	E2 1SL42ACD21AB	E2 1SL42ACD29AB	E2 1SL22ACD21AB	E2 1SL22ACD29AB
 red		E2 1SL12ACD31AB	E2 1SL12ACD39AB	E2 1SL42ACD31AB	E2 1SL42ACD39AB	E2 1SL22ACD31AB	E2 1SL22ACD39AB
 green		E2 1SL12ACD41AB	E2 1SL12ACD49AB	E2 1SL42ACD41AB	E2 1SL42ACD49AB	E2 1SL22ACD41AB	E2 1SL22ACD49AB
 yellow		E2 1SL12ACD51AB	E2 1SL12ACD59AB	E2 1SL42ACD51AB	E2 1SL42ACD59AB	E2 1SL22ACD51AB	E2 1SL22ACD59AB
 blue		E2 1SL12ACD61AB	E2 1SL12ACD69AB	E2 1SL42ACD61AB	E2 1SL42ACD69AB	E2 1SL22ACD61AB	E2 1SL22ACD69AB
 orange		E2 1SL12ACD81AB	E2 1SL12ACD89AB	E2 1SL42ACD81AB	E2 1SL42ACD89AB	E2 1SL22ACD81AB	E2 1SL22ACD89AB
 white		E2 1SL12ECD21AB	E2 1SL12ECD29AB	E2 1SL42ECD21AB	E2 1SL42ECD29AB	E2 1SL22ECD21AB	E2 1SL22ECD29AB
 red		E2 1SL12ECD31AB	E2 1SL12ECD39AB	E2 1SL42ECD31AB	E2 1SL42ECD39AB	E2 1SL22ECD31AB	E2 1SL22ECD39AB
 green		E2 1SL12ECD41AB	E2 1SL12ECD49AB	E2 1SL42ECD41AB	E2 1SL42ECD49AB	E2 1SL22ECD41AB	E2 1SL22ECD49AB
 yellow		E2 1SL12ECD51AB	E2 1SL12ECD59AB	E2 1SL42ECD51AB	E2 1SL42ECD59AB	E2 1SL22ECD51AB	E2 1SL22ECD59AB
 blue		E2 1SL12ECD61AB	E2 1SL12ECD69AB	E2 1SL42ECD61AB	E2 1SL42ECD69AB	E2 1SL22ECD61AB	E2 1SL22ECD69AB
 orange		E2 1SL12ECD81AB	E2 1SL12ECD89AB	E2 1SL42ECD81AB	E2 1SL42ECD89AB	E2 1SL22ECD81AB	E2 1SL22ECD89AB

Legend:  Maintained  Spring-return

On request, knob selector switches can be customized with symbols and inscriptions.

Items with code on **green** background are stock items

3-slot mounting adapter

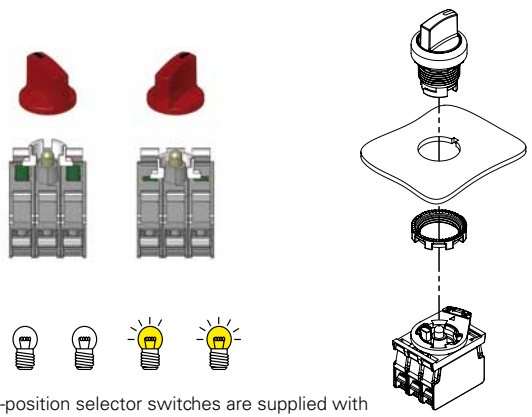

The illuminated 2-position selector switches are supplied with white actuators that activate the contact blocks as the figure shows.

Selection table for illuminated selector switches



Actuator colour and engraving	Three positions	short handle		knob		long handle	
		black bezel	Satin chrome bezel	black bezel	Satin chrome bezel	black bezel	Satin chrome bezel
white	↓	E2 1SL13ACH21AB	E2 1SL13ACH29AB	E2 1SL43ACH21AB	E2 1SL43ACH29AB	E2 1SL23ACH21AB	E2 1SL23ACH29AB
red	↓	E2 1SL13ACH31AB	E2 1SL13ACH39AB	E2 1SL43ACH31AB	E2 1SL43ACH39AB	E2 1SL23ACH31AB	E2 1SL23ACH39AB
green	↓	E2 1SL13ACH41AB	E2 1SL13ACH49AB	E2 1SL43ACH41AB	E2 1SL43ACH49AB	E2 1SL23ACH41AB	E2 1SL23ACH49AB
yellow	↓	E2 1SL13ACH51AB	E2 1SL13ACH59AB	E2 1SL43ACH51AB	E2 1SL43ACH59AB	E2 1SL23ACH51AB	E2 1SL23ACH59AB
blue	↓	E2 1SL13ACH61AB	E2 1SL13ACH69AB	E2 1SL43ACH61AB	E2 1SL43ACH69AB	E2 1SL23ACH61AB	E2 1SL23ACH69AB
orange	↓	E2 1SL13ACH81AB	E2 1SL13ACH89AB	E2 1SL43ACH81AB	E2 1SL43ACH89AB	E2 1SL23ACH81AB	E2 1SL23ACH89AB
white	↘	E2 1SL13ECH21AB	E2 1SL13ECH29AB	E2 1SL43ECH21AB	E2 1SL43ECH29AB	E2 1SL23ECH21AB	E2 1SL23ECH29AB
red	↘	E2 1SL13ECH31AB	E2 1SL13ECH39AB	E2 1SL43ECH31AB	E2 1SL43ECH39AB	E2 1SL23ECH31AB	E2 1SL23ECH39AB
green	↘	E2 1SL13ECH41AB	E2 1SL13ECH49AB	E2 1SL43ECH41AB	E2 1SL43ECH49AB	E2 1SL23ECH41AB	E2 1SL23ECH49AB
yellow	↘	E2 1SL13ECH51AB	E2 1SL13ECH59AB	E2 1SL43ECH51AB	E2 1SL43ECH59AB	E2 1SL23ECH51AB	E2 1SL23ECH59AB
blue	↘	E2 1SL13ECH61AB	E2 1SL13ECH69AB	E2 1SL43ECH61AB	E2 1SL43ECH69AB	E2 1SL23ECH61AB	E2 1SL23ECH69AB
orange	↘	E2 1SL13ECH81AB	E2 1SL13ECH89AB	E2 1SL43ECH81AB	E2 1SL43ECH89AB	E2 1SL23ECH81AB	E2 1SL23ECH89AB
white	↙	E2 1SL13FCH21AB	E2 1SL13FCH29AB	E2 1SL43FCH21AB	E2 1SL43FCH29AB	E2 1SL23FCH21AB	E2 1SL23FCH29AB
red	↙	E2 1SL13FCH31AB	E2 1SL13FCH39AB	E2 1SL43FCH31AB	E2 1SL43FCH39AB	E2 1SL23FCH31AB	E2 1SL23FCH39AB
green	↙	E2 1SL13FCH41AB	E2 1SL13FCH49AB	E2 1SL43FCH41AB	E2 1SL43FCH49AB	E2 1SL23FCH41AB	E2 1SL23FCH49AB
yellow	↙	E2 1SL13FCH51AB	E2 1SL13FCH59AB	E2 1SL43FCH51AB	E2 1SL43FCH59AB	E2 1SL23FCH51AB	E2 1SL23FCH59AB
blue	↙	E2 1SL13FCH61AB	E2 1SL13FCH69AB	E2 1SL43FCH61AB	E2 1SL43FCH69AB	E2 1SL23FCH61AB	E2 1SL23FCH69AB
orange	↙	E2 1SL13FCH81AB	E2 1SL13FCH89AB	E2 1SL43FCH81AB	E2 1SL43FCH89AB	E2 1SL23FCH81AB	E2 1SL23FCH89AB
white	↕	E2 1SL13GCH21AB	E2 1SL13GCH29AB	E2 1SL43GCH21AB	E2 1SL43GCH29AB	E2 1SL23GCH21AB	E2 1SL23GCH29AB
red	↕	E2 1SL13GCH31AB	E2 1SL13GCH39AB	E2 1SL43GCH31AB	E2 1SL43GCH39AB	E2 1SL23GCH31AB	E2 1SL23GCH39AB
green	↕	E2 1SL13GCH41AB	E2 1SL13GCH49AB	E2 1SL43GCH41AB	E2 1SL43GCH49AB	E2 1SL23GCH41AB	E2 1SL23GCH49AB
yellow	↕	E2 1SL13GCH51AB	E2 1SL13GCH59AB	E2 1SL43GCH51AB	E2 1SL43GCH59AB	E2 1SL23GCH51AB	E2 1SL23GCH59AB
blue	↕	E2 1SL13GCH61AB	E2 1SL13GCH69AB	E2 1SL43GCH61AB	E2 1SL43GCH69AB	E2 1SL23GCH61AB	E2 1SL23GCH69AB
orange	↕	E2 1SL13GCH81AB	E2 1SL13GCH89AB	E2 1SL43GCH81AB	E2 1SL43GCH89AB	E2 1SL23GCH81AB	E2 1SL23GCH89AB

Legend: Maintained Spring-return

On request, knob selector switches can be customized with symbols and inscriptions.

Items with code on green background are stock items

3-slot mounting adapter

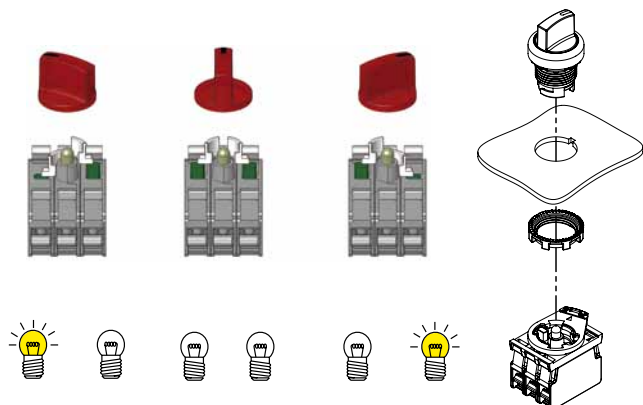

The illuminated 3-position selector switches are supplied with white actuators that activate the contact blocks as the figure shows.

Selection table for complete units with four-position selector switches

Four-position selector switches

Illuminated four-position selector switches



Actuator colour and engraving	Four positions	Contacts			4 positions		Contacts			4 positions, illuminated	
		pos. 2	pos. 3	pos. 1	black bezel	Satin chrome bezel	pos. 2	pos. 3	pos. 1	black bezel	Satin chrome bezel
black		1NO+1NC	-	1NO+1NC	E2 AC-DXBC2201	E2 AC-DXBC2203	-	-	-	-	-
white		1NO+1NC	-	1NO+1NC	E2 AC-DXBC2209	E2 AC-DXBC2211	1NO+1NC	LED	1NO+1NC	E2 AC-DXBC2257	E2 AC-DXBC2259
red		1NO+1NC	-	1NO+1NC	E2 AC-DXBC2217	E2 AC-DXBC2219	1NO+1NC	LED	1NO+1NC	E2 AC-DXBC2265	E2 AC-DXBC2267
green		1NO+1NC	-	1NO+1NC	E2 AC-DXBC2225	E2 AC-DXBC2227	1NO+1NC	LED	1NO+1NC	E2 AC-DXBC2273	E2 AC-DXBC2275
yellow		1NO+1NC	-	1NO+1NC	E2 AC-DXBC2233	E2 AC-DXBC2235	1NO+1NC	LED	1NO+1NC	E2 AC-DXBC2281	E2 AC-DXBC2283
blue		1NO+1NC	-	1NO+1NC	E2 AC-DXBC2241	E2 AC-DXBC2243	1NO+1NC	LED	1NO+1NC	E2 AC-DXBC2289	E2 AC-DXBC2291
orange		1NO+1NC	-	1NO+1NC	E2 AC-DXBC2249	E2 AC-DXBC2251	1NO+1NC	LED	1NO+1NC	E2 AC-DXBC2297	E2 AC-DXBC2299
black		1NO+1NC	-	1NO+1NC	E2 AC-DXBC2200	E2 AC-DXBC2202	-	-	-	-	-
white		1NO+1NC	-	1NO+1NC	E2 AC-DXBC2208	E2 AC-DXBC2210	1NO+1NC	LED	1NO+1NC	E2 AC-DXBC2256	E2 AC-DXBC2258
red		1NO+1NC	-	1NO+1NC	E2 AC-DXBC2216	E2 AC-DXBC2218	1NO+1NC	LED	1NO+1NC	E2 AC-DXBC2264	E2 AC-DXBC2266
green		1NO+1NC	-	1NO+1NC	E2 AC-DXBC2224	E2 AC-DXBC2226	1NO+1NC	LED	1NO+1NC	E2 AC-DXBC2272	E2 AC-DXBC2274
yellow		1NO+1NC	-	1NO+1NC	E2 AC-DXBC2232	E2 AC-DXBC2234	1NO+1NC	LED	1NO+1NC	E2 AC-DXBC2280	E2 AC-DXBC2282
blue		1NO+1NC	-	1NO+1NC	E2 AC-DXBC2240	E2 AC-DXBC2242	1NO+1NC	LED	1NO+1NC	E2 AC-DXBC2288	E2 AC-DXBC2290
orange		1NO+1NC	-	1NO+1NC	E2 AC-DXBC2248	E2 AC-DXBC2250	1NO+1NC	LED	1NO+1NC	E2 AC-DXBC2296	E2 AC-DXBC2298

Note: The LED supplied with the illuminated selector switch has a supply voltage of 12 ... 30 Vac/dc. Other voltages on request.

Legend: Maintained Spring-return

Wiring diagram

		Selector position			
		I	II	III	IV
pos. 2	contacts .1 .2				
	contacts .3 .4				
pos. 1	contacts .1 .2				
	contacts .3 .4				

■ closed contact □ open contact

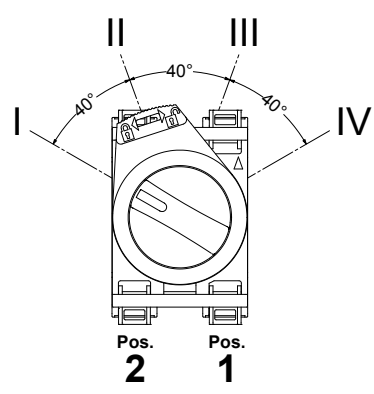

Four-position selector switches

The combination of this version of the selector with the dedicated double contact blocks allows to close a single contact in each of the four positions; the angular rotation of the lever remains the same for versions with 2, 3 and 4 positions, thus facilitating the handling of the device.

The 4-position selector must not be combined with contact blocks different from those supplied.

Handle type

The four-position selector can be supplied with three different handle types. For further information contact our sales office.



Complete units with two- or three-position selector switches



Actuator colour and engraving	Positions	Contacts			2 positions
		pos. 2	pos. 3	pos. 1	black bezel
● black	↙	-	1NO	-	E2 AC-DXBC1401 E2 1SE12AVA11AB + E2 1BAC11 + E2 CP10G2V1
● black	↘	-	1NO	-	E2 AC-DXBC1402 E2 1SE12EVA11AB + E2 1BAC11 + E2 CP10G2V1

Other combinations on request.



Actuator colour and engraving	Positions	Contacts			3 positions
		pos. 2	pos. 3	pos. 1	black bezel
● black	↙	1NO	-	1NO	E2 AC-DXBC1405 E2 1SE13ACE11AB + E2 1BAC11 + E2 CP10G2V1 + E2 CP10G2V1
● black	↘	1NO	-	1NO	E2 AC-DXBC1406 E2 1SE13GCE11AB + E2 1BAC11 + E2 CP10G2V1 + E2 CP10G2V1

Other combinations on request.

Complete units with two- or three-position illuminated selector switches



Actuator colour and engraving	Positions	Contacts			2 positions
		pos. 2	pos. 3	pos. 1	black bezel
○ white	↙	1NO	LED	1NC ⊕	E2 AC-DXBC1805 E2 1SL12AVD21AB + E2 1BAC11 + E2 CP10G2V1 + E2 LP1A2V1 + E2 CP01G2V1
● green	↙	1NO	LED	1NC ⊕	E2 AC-DXBC1801 E2 1SL12AVD41AB + E2 1BAC11 + E2 CP10G2V1 + E2 LP1A4V1 + E2 CP01G2V1

Other combinations on request.



Actuator colour and engraving	Positions	Contacts			3 positions
		pos. 2	pos. 3	pos. 1	black bezel
○ white	↙	1NO	LED	1NC ⊕	E2 AC-DXBC1806 E2 1SL13ACH21AB + E2 1BAC11 + E2 CP10G2V1 + E2 LP1A2V1 + E2 CP01G2V1
● green	↙	1NO	LED	1NC ⊕	E2 AC-DXBC1803 E2 1SL13ACH41AB + E2 1BAC11 + E2 CP10G2V1 + E2 LP1A4V1 + E2 CP01G2V1

Other combinations on request.

Legend: ↙ Maintained ↘ Spring-return

→ For data regarding contact blocks and LED units, please see the respective chapters.

Minimum distances for installation

All measures in the drawings are in mm

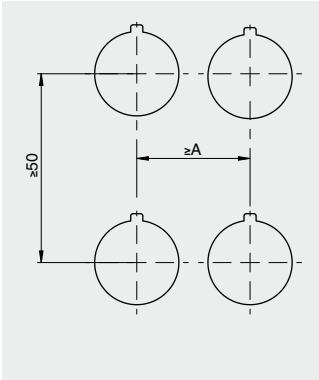

3-slot mounting adapter
A=30 mm
4-slot mounting adapter
A=40 mm

Maximum number of contact blocks

3-slot mounting adapter

4-slot mounting adapter

Selector switches E2 •SE••••••••



maximum number:
6 contact blocks
3 levels

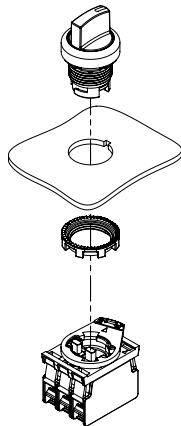

Illuminated selector switches E2
•SL••••••••

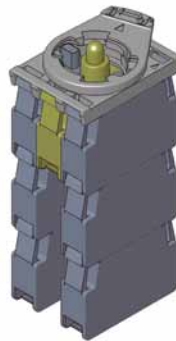

maximum number:
6 contact blocks
3 levels

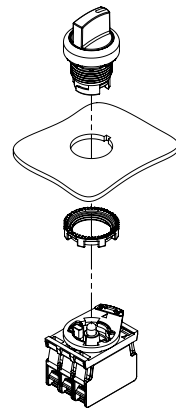

Selector switches E2 •SE••••••••

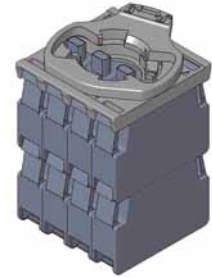

maximum number:
8 contact blocks
2 levels

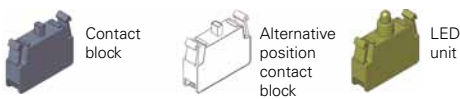
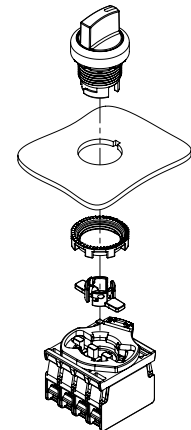

The mounting of the actuators for 4-slot base must be carried out after fixing the selector.

Dimensions

All measures in the drawings are in mm

Selector switch with short handle

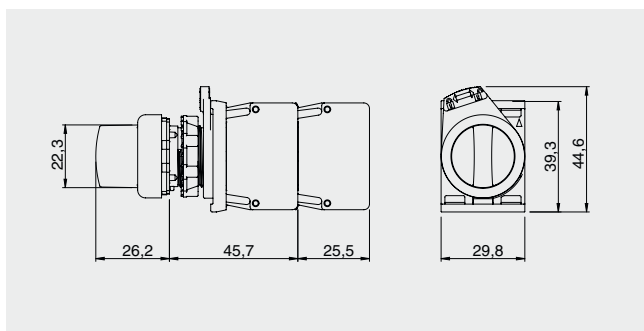

Knob selector switch

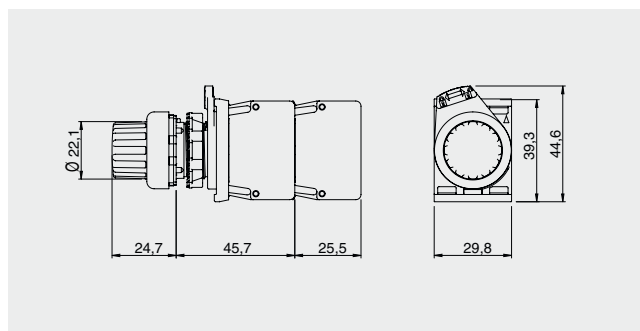

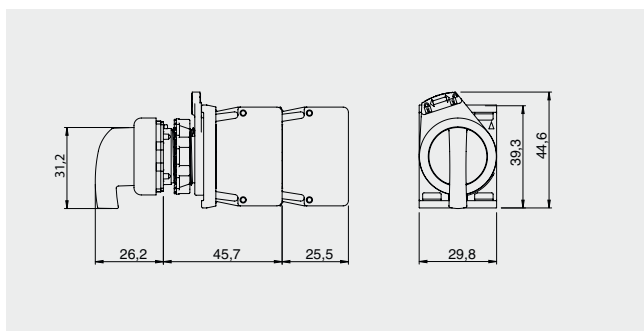

Selector switch with long handle



→ The 2D and 3D files are available at www.pizzato.com

Actuators

Packs of 10 pcs.

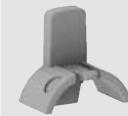
Article	Description
 VE AS1212	Black closed actuator for 3-slot base. Actuates 2 contact blocks at the same time. For E2 ●SE●●●●●● selector switches
 VE AS1213	White open actuator for 3-slot base. Actuates 1 contact block. For E2 ●SE●●●●●●, E2 ●SL●●●●●● selector switches
 VE AS1216	Grey closed actuator for 4-slot base. Actuates 2 contact blocks at the same time. For E2 ●SE●●●●●● selector switches

Note: 2 actuators needed for each selector.

Shaped ring

Packs of 50 pcs.

Article	Description
 VE GP12H1A	Shaped ring for single device Not applicable in presence of label holders, adapters from Ø 22 to Ø 30 mm, guards or protection caps.

Fixing ring

Packs of 20 pcs.

Article	Description
 VE GF720A	Metal fixing ring

Accessories

→ More ACCESSORIES on page 135

Items with code on **green** background are stock items

